

Technical drawings are subject to change without notice. All millimeter dimensions are exact and supersede inch conversions.

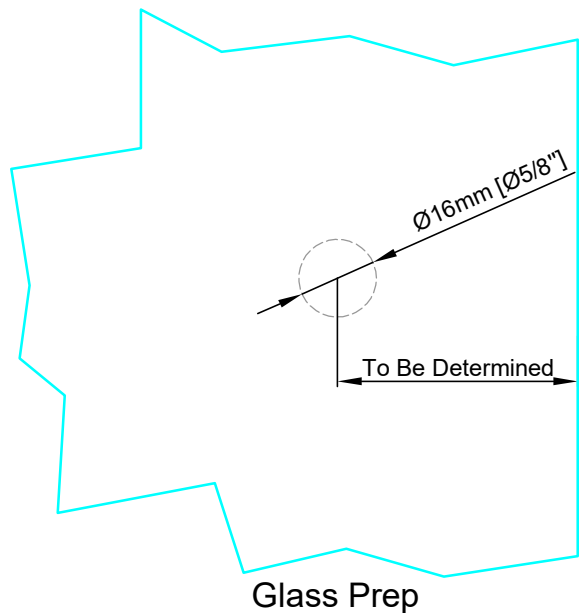
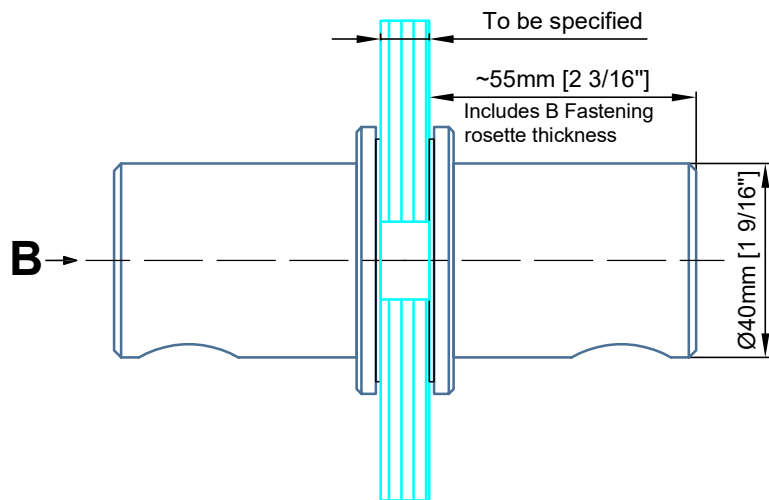
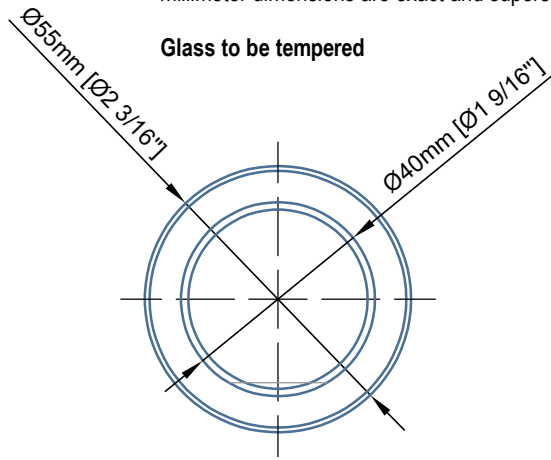
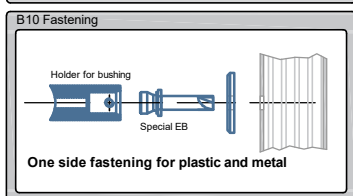
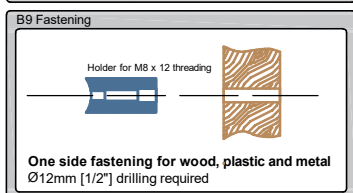
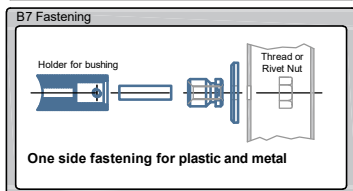
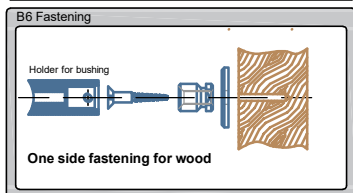
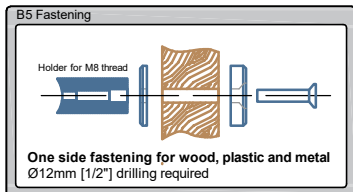
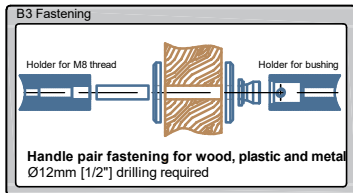
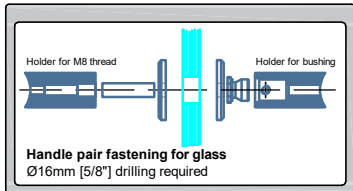

**SA.3300 cup pull** (for wood or glass doors)

Date Prepared: Nov 2018

Prepared By: CDA



**LUXURY**  
 GLASS & HARDWARE

www.luxuryglassandhardware.com