

Technical drawings are subject to change without notice. All millimeter dimensions are exact and supersede inch conversions.

**Glass to be tempered**

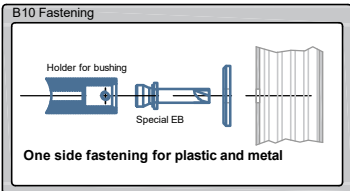
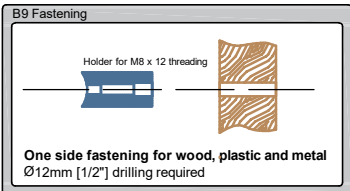
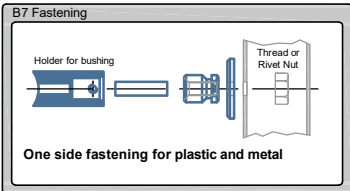
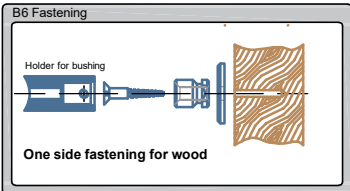
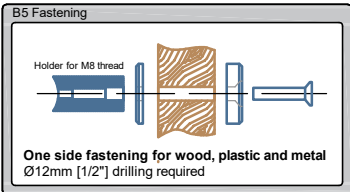
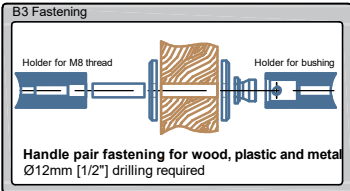
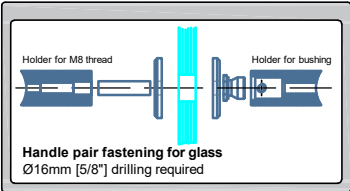
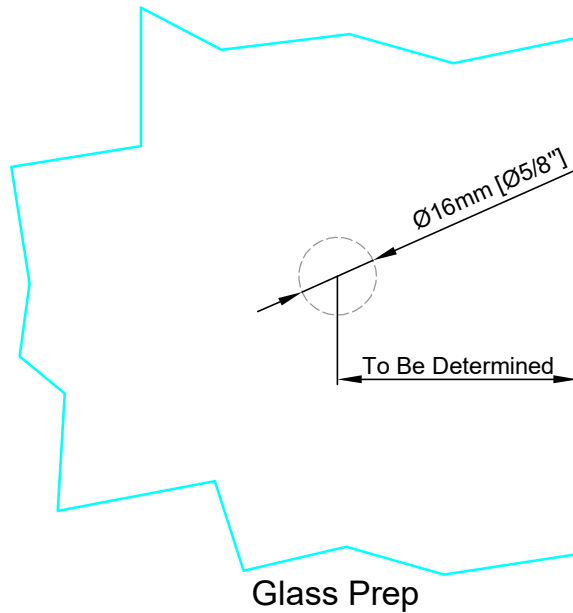
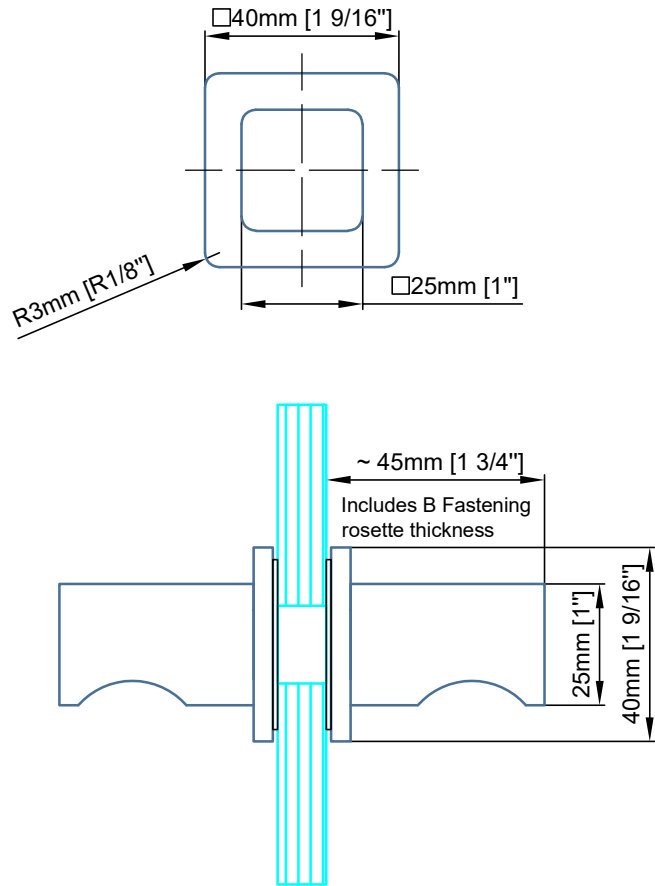

**SA.3315.25 cup pull** *(for wood or glass doors)*

Date Prepared: Nov 2018

Prepared By: CDA



**LUXURY**  
GLASS & HARDWARE

www.luxuryglassandhardware.com